



Preliminary

KA5L0380R

S P S

The SPS product family is specially designed for an off-line SMPS with minimal external components. The SPS consist of high voltage power SenseFET and current mode PWM IC.

Included PWM controller features integrated fixed frequency oscillator, under voltage lock-out, leading edge blanking, optimized gate turn-on/turn-off driver, thermal shutdown protection, over voltage protection, and temperature compensated precision current sources for loop compensation and fault protection circuitry. Compared to discrete MOSFET and PWM controller or RCC solution, a SPS can reduce total component count, design size, weight and at the same time increase efficiency, productivity, and system reliability.

It has a basic platform well suited for cost-effective design in either a flyback converter or a forward converter.

FEATURES

- Precision fixed operating frequency (50kHz)
- Low start-up current (Typ. 100mA)
- Pulse by pulse current limiting
- Over current protection
- Over voltage protection (Min. 25V)
- Internal thermal shutdown function
- Under voltage lockout
- Internal high voltage sense FET
- Auto-restart mode

BLOCK DIAGRAM

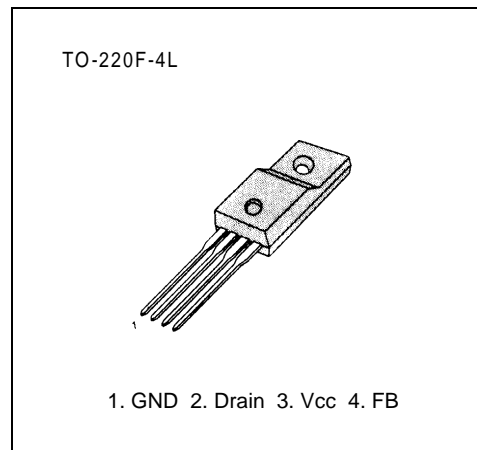
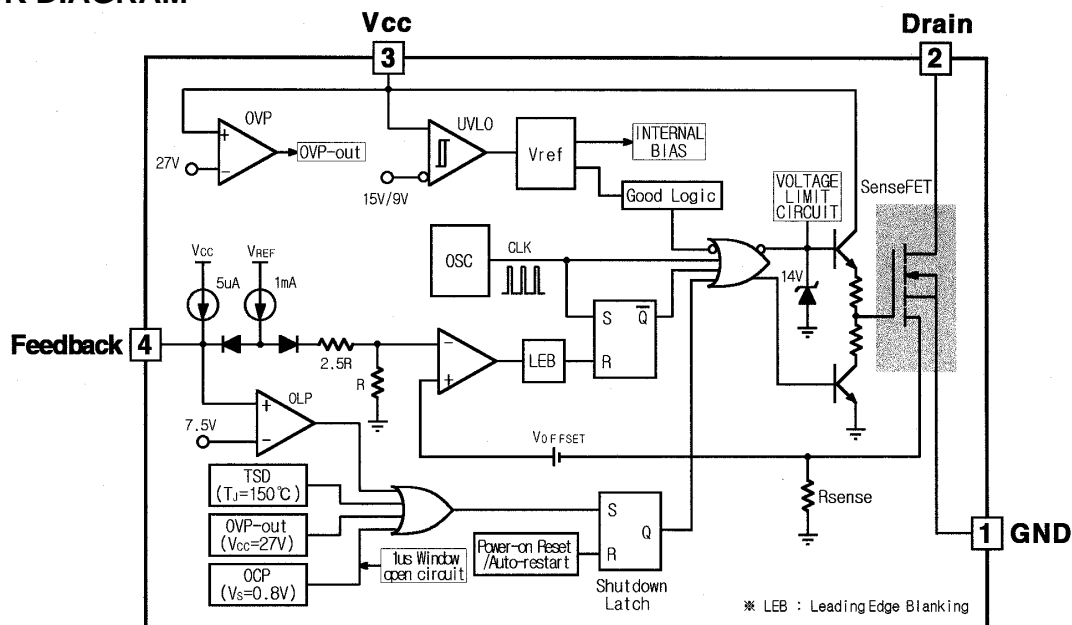

ORDERING INFORMATION

Device	Package	Topr (°C)
KA5L0380R	TO-220F-4L	-25°C to +85°C

ABSOLUTE MAXIMUM RATINGS

Characteristic	Symbol	Value	Unit
Drain-source (GND) voltage ⁽¹⁾	V _{DSS}	800	V
Drain-Gate voltage (R _{GS} =1MΩ)	V _{DGR}	800	V
Gate-source (GND) voltage	V _{GS}	±30	V
Drain current pulsed ⁽²⁾	I _{DM}	12	A _{DC}
Single pulsed avalanche energy ⁽³⁾	E _{AS}	95	mJ
Avalanche current ⁽⁴⁾	I _{AS}	–	A
Continuous drain current (T _C =25°C)	I _D	3.0	A _{DC}
Continuous drain current (T _C =100°C)	I _D	2.1	A _{DC}
Supply voltage	V _{CC}	30	V
Analog input voltage range	V _{FB}	–0.3 to V _{SD}	V
Total power dissipation	P _D (wt H/S)	35	W
	Derating	0.28	W/°C
Operating temperature	T _{OPR}	–25 to +85	°C
Storage temperature	T _{STG}	–55 to +150	°C

NOTES:

1. T_j=25°C to 150°C
2. Repetitive rating: Pulse width limited by maximum junction temperature
3. L=51mH, starting T_j=25°C
4. L=13uH, starting T_j=25°C

ELECTRICAL CHARACTERISTICS (SFET part)

(Ta=25°C unless otherwise specified)

Characteristic	Symbol	Test condition	Min.	Typ.	Max.	Unit
Drain-source breakdown voltage	BV_{DSS}	$V_{GS}=0V, I_D=50\mu A$	800	–	–	V
Zero gate voltage drain current	I_{DSS}	$V_{DS}=\text{Max.}, \text{Rating}, V_{GS}=0V$	–	–	250	μA
		$V_{DS}=0.8\text{Max.}, \text{Rating}, V_{GS}=0V, T_C=125^\circ C$	–	–	1000	μA
Static drain-source on resistance ^(note)	$R_{DS(ON)}$	$V_{GS}=10V, I_D=0.5A$	–	4	5	Ω
Forward transconductance ^(note)	gfs	$V_{DS}=50V, I_D=0.5A$	1.5	2.5	–	S
Input capacitance	C_{iss}	$V_{GS}=0V, V_{DS}=25V, f=1\text{MHz}$	–	779	–	pF
Output capacitance	C_{oss}		–	75.6	–	
Reverse transfer capacitance	C_{rss}		–	24.9	–	
Turn on delay time	td(on)	$V_{DD}=0.5BV_{DSS}, I_D=1.0A$ (MOSFET switching time are essentially independent of operating temperature)	–	40	–	nS
Rise time	tr		–	95	–	
Turn off delay time	td(off)		–	150	–	
Fall time	tf		–	60	–	
Total gate charge (gate-source+gate-drain)	Qg	$V_{GS}=10V, I_D=1.0A, V_{DS}=0.5BV_{DSS}$ (MOSFET switching time are essentially independent of operating temperature)	–	–	34	nC
Gate-source charge	Qgs		–	7.2	–	
Gate-drain (Miller) charge	Qgd		–	12.1	–	

NOTE: Pulse test: Pulse width $\leq 300\mu S$, duty cycle $\leq 2\%$

ELECTRICAL CHARACTERISTICS (Control part)

(Ta=25°C unless otherwise specified)

Characteristic	Symbol	Test condition	Min.	Typ.	Max.	Unit
REFERENCE SECTION						
Output voltage ⁽¹⁾	Vref	Ta=25°C	4.80	5.00	5.20	V
Temperature Stability ⁽¹⁾⁽²⁾	Vref/ΔT	-25°C≤Ta≤+85°C	-	0.3	0.6	mV/°C
OSCILLATOR SECTION						
Initial accuracy	F _{OSC}	Ta=25°C	45	50	55	kHz
Frequency change with temperature ⁽²⁾	ΔF/ΔT	-25°C≤Ta≤+85°C	-	±5	±10	%
PWM SECTION						
Maximum duty cycle	Dmax	-	74	77	80	%
FEEDBACK SECTION						
Feedback source current	I _{FB}	Ta=25°C, 0V≤Vfb≤3V	0.7	0.9	1.1	mA
Shutdown delay current	I _{delay}	Ta=25°C, 5V≤Vfb≤V _{SD}	4	5	6	μA
OVER CURRENT PROTECTION SECTION						
Over current protection	I _L (max)	Max. inductor current	1.89	2.15	2.41	A
UVLO SECTION						
Start threshold voltage	V _{th} (H)	-	8.4	9	9.6	V
Minimum operating voltage	V _{th} (L)	After turn on	14	15	16	V
TOTAL STANDBY CURRENT SECTION						
Start current	I _{ST}	V _{CC} =14V	-	0.1	0.17	mA
Operating supply current (control part only)	I _{OPR}	V _{CC} ≤28	-	7	12	mA
SHUTDOWN SECTION						
Shutdown Feedback voltage	V _{SD}	Vfb≥6.5V	6.9	7.5	8.1	V
Thermal shutdown temperature (Tj) ⁽¹⁾	T _{SD}	-	140	160	-	°C
Over voltage protection	V _{OVP}	V _{CC} ≥24V	25	27	29	V

NOTES:

1. These parameters, although guaranteed, are not 100% tested in production
2. These parameters, although guaranteed, are tested in EDS (wafer test) process

TYPICAL PERFORMANCE CHARACTERISTICS (SFET part)

Fig 1. Output Characteristics

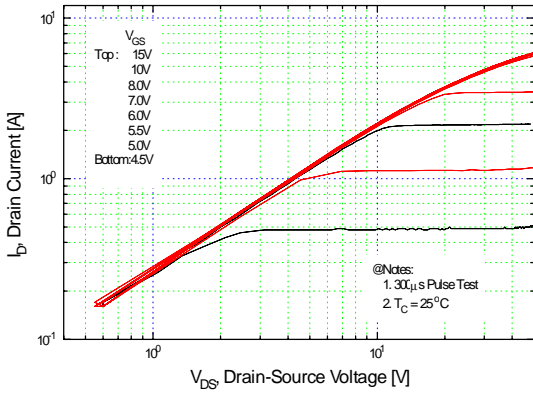

Fig. 2 Transfer Characteristics

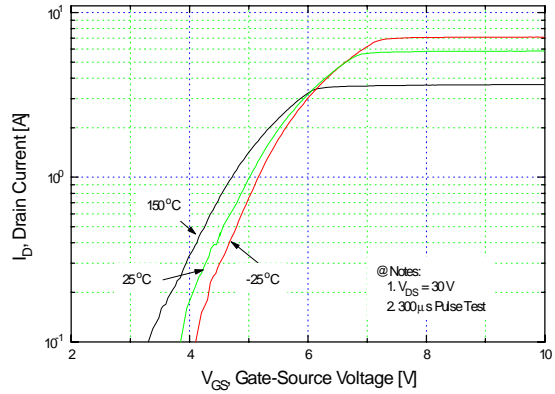

Fig. 3 On-Resistance vs. Drain Current

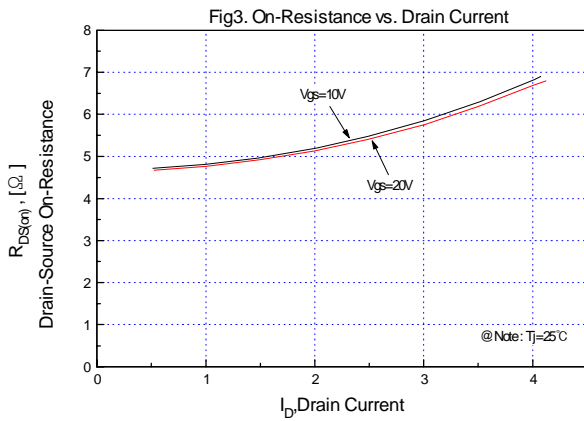

Fig. 4 Source-Drain Diode Forward Voltage

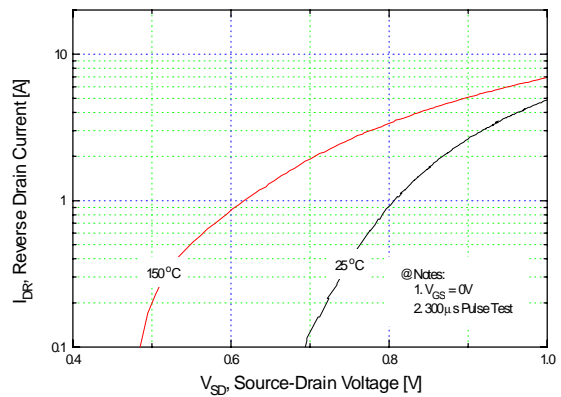

Fig.5 Capacitance vs. Drain-Source Voltage

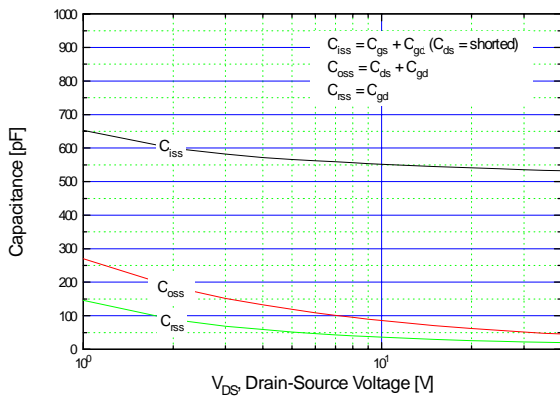
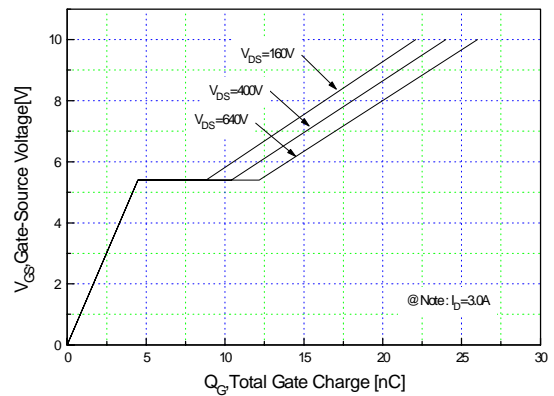

Fig. 6 Gate Charge vs. Gate-Source Voltage



TYPICAL PERFORMANCE CHARACTERISTICS (Continued)

Fig. 7 Breakdown Voltage vs. Temperature

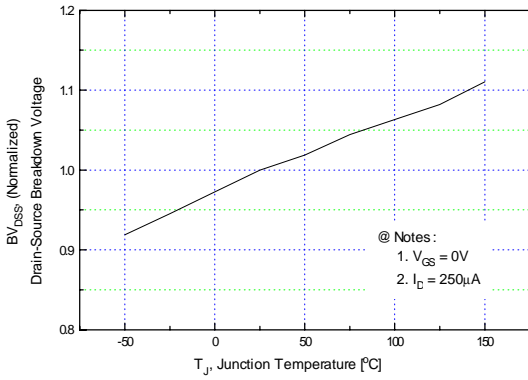

Fig. 8 On-Resistance vs. Temperature

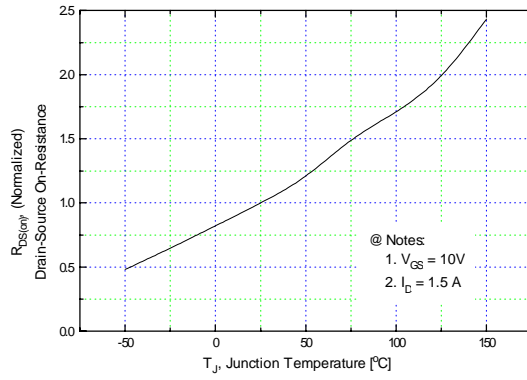

Fig. 9 Max. Safe Operating Area

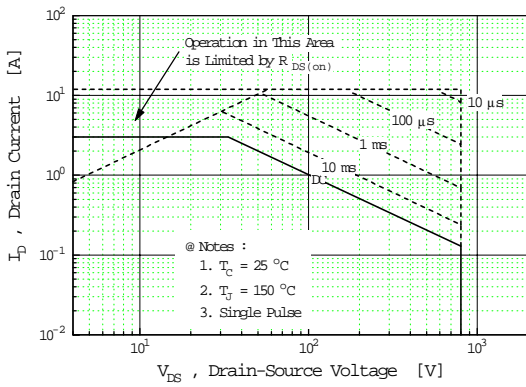

Fig. 10 Max. Drain Current vs. Case Temperature

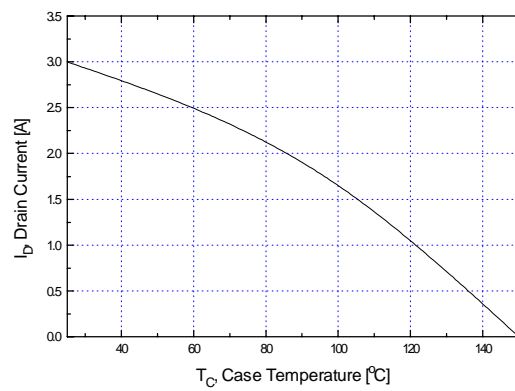
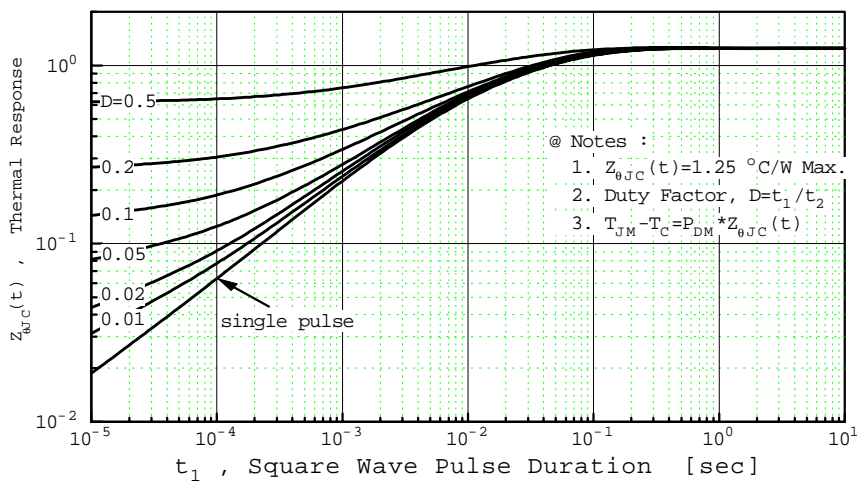
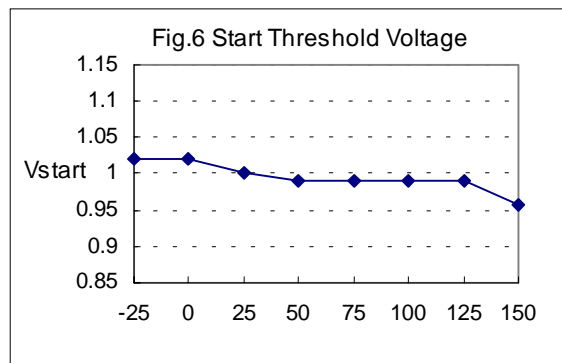
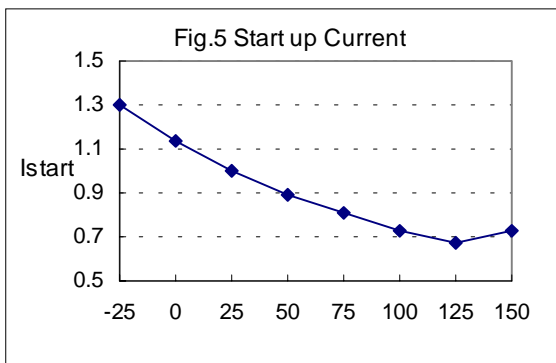
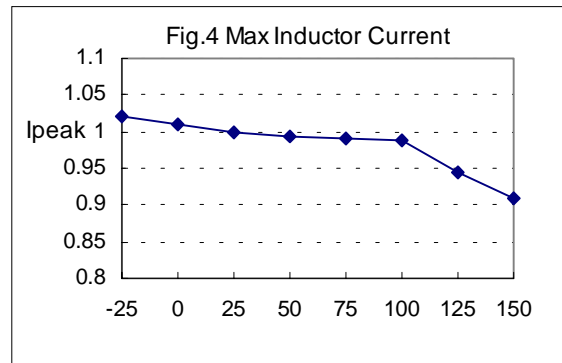
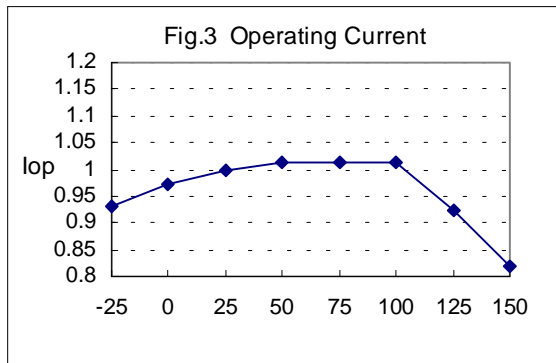
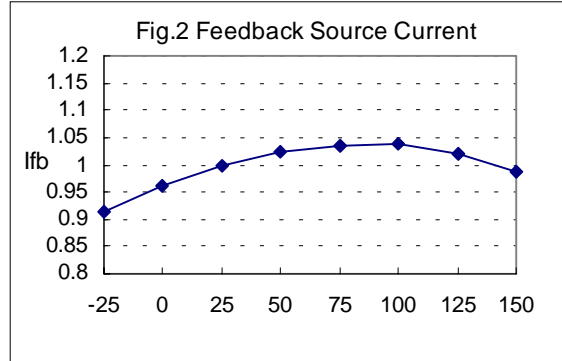
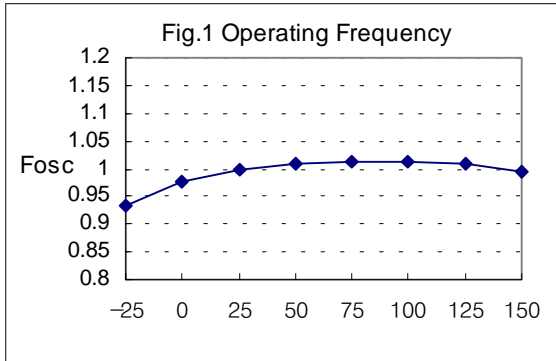

Fig. 11 Thermal Response



TYPICAL PERFORMANCE CHARACTERISTICS (Control part)



TYPICAL PERFORMANCE CHARACTERISTICS (Continued)

(These characteristic graphs are normalized at Ta=25°C)

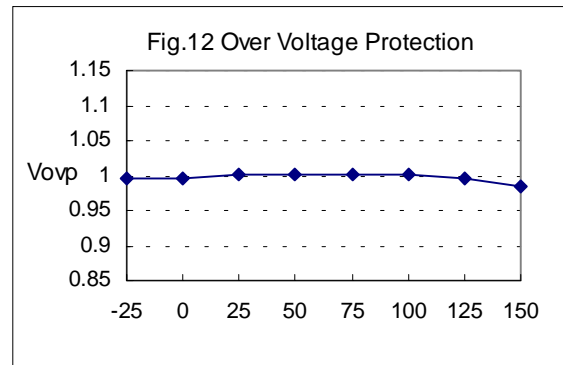
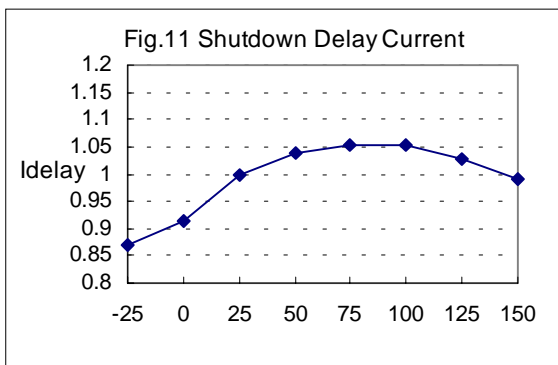
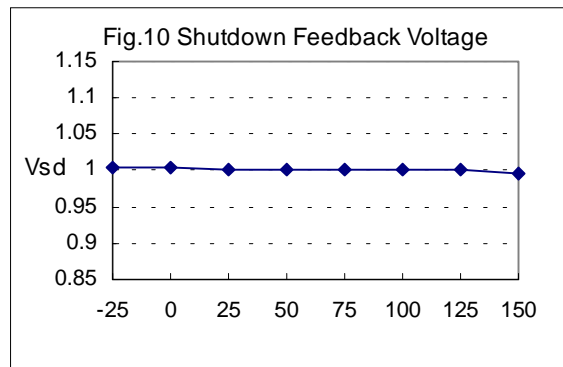
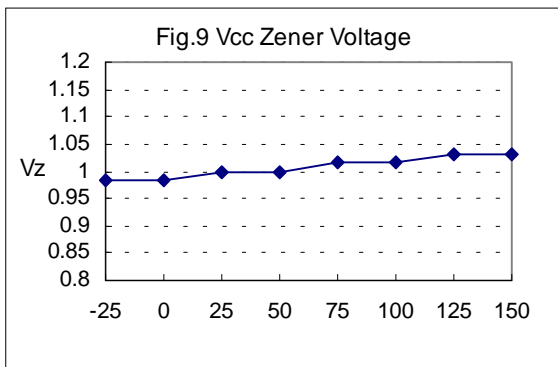
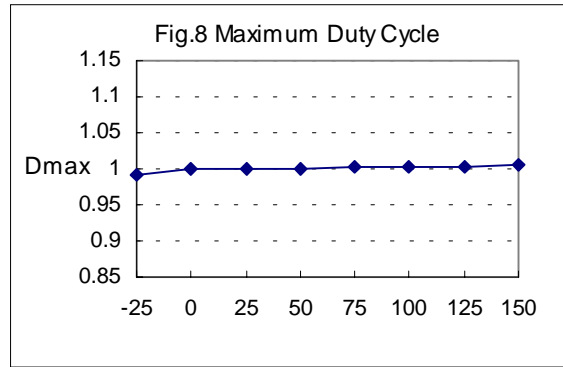
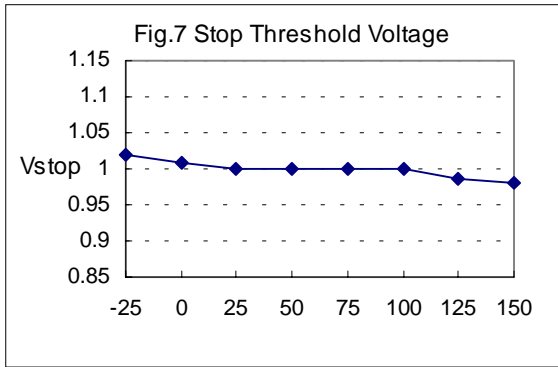

TYPICAL PERFORMANCE CHARACTERISTICS (Continued)

(These characteristic graphs are normalized at Ta=25°C)

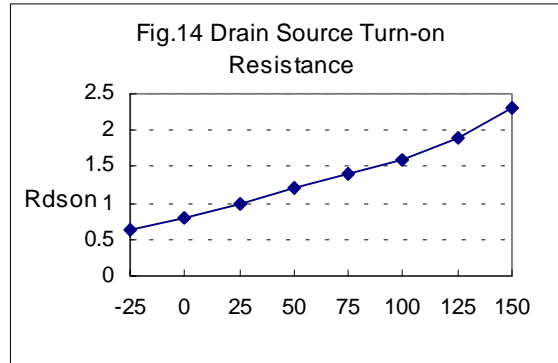
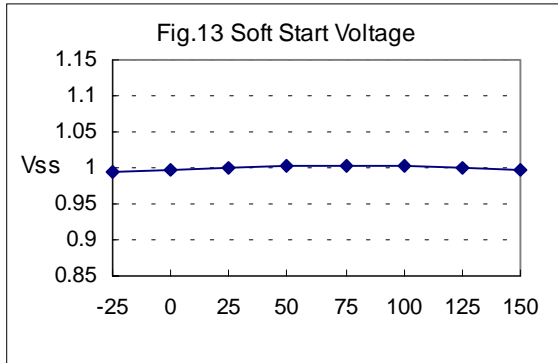

ON Semiconductor and  are trademarks of Semiconductor Components Industries, LLC dba ON Semiconductor or its subsidiaries in the United States and/or other countries. ON Semiconductor owns the rights to a number of patents, trademarks, copyrights, trade secrets, and other intellectual property. A listing of ON Semiconductor's product/patent coverage may be accessed at www.onsemi.com/site/pdf/Patent-Marking.pdf. ON Semiconductor reserves the right to make changes without further notice to any products herein. ON Semiconductor makes no warranty, representation or guarantee regarding the suitability of its products for any particular purpose, nor does ON Semiconductor assume any liability arising out of the application or use of any product or circuit, and specifically disclaims any and all liability, including without limitation special, consequential or incidental damages. Buyer is responsible for its products and applications using ON Semiconductor products, including compliance with all laws, regulations and safety requirements or standards, regardless of any support or applications information provided by ON Semiconductor. "Typical" parameters which may be provided in ON Semiconductor data sheets and/or specifications can and do vary in different applications and actual performance may vary over time. All operating parameters, including "Typicals" must be validated for each customer application by customer's technical experts. ON Semiconductor does not convey any license under its patent rights nor the rights of others. ON Semiconductor products are not designed, intended, or authorized for use as a critical component in life support systems or any FDA Class 3 medical devices or medical devices with a same or similar classification in a foreign jurisdiction or any devices intended for implantation in the human body. Should Buyer purchase or use ON Semiconductor products for any such unintended or unauthorized application, Buyer shall indemnify and hold ON Semiconductor and its officers, employees, subsidiaries, affiliates, and distributors harmless against all claims, costs, damages, and expenses, and reasonable attorney fees arising out of, directly or indirectly, any claim of personal injury or death associated with such unintended or unauthorized use, even if such claim alleges that ON Semiconductor was negligent regarding the design or manufacture of the part. ON Semiconductor is an Equal Opportunity/Affirmative Action Employer. This literature is subject to all applicable copyright laws and is not for resale in any manner.

PUBLICATION ORDERING INFORMATION

LITERATURE FULFILLMENT:

Literature Distribution Center for ON Semiconductor
19521 E. 32nd Pkwy, Aurora, Colorado 80011 USA
Phone: 303-675-2175 or 800-344-3860 Toll Free USA/Canada
Fax: 303-675-2176 or 800-344-3867 Toll Free USA/Canada
Email: orderlit@onsemi.com

N. American Technical Support: 800-282-9855 Toll Free
USA/Canada
Europe, Middle East and Africa Technical Support:
Phone: 421 33 790 2910
Japan Customer Focus Center
Phone: 81-3-5817-1050

ON Semiconductor Website: www.onsemi.com
Order Literature: <http://www.onsemi.com/orderlit>
For additional information, please contact your local
Sales Representative