

Interference Suppression Film Capacitors MKP Radial Potted Type

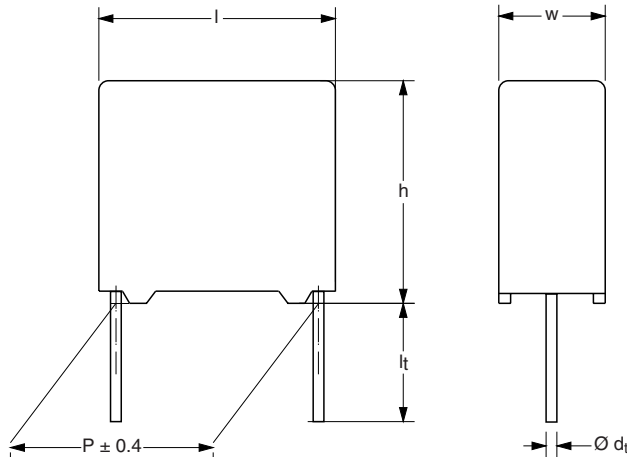

Dimensions in mm

APPLICATIONS

For standard across the line X2 applications

See also application note:

www.vishay.com/docs/28153/anaccaps.pdf

REFERENCE STANDARDS

"IEC 60384-14 ed 3 and EN 60384-14"

"IEC 60065, pass. flamm. class B"

CSA-C22.2 No 1; UL1414

ENEC; CQC

UL1283; CSA E384-14

MARKING

C-value; tolerance; rated voltage; sub-class; manufacturer's type designation; code for dielectric material; manufacturer location; manufacturer's logo; year and week; safety approvals.

DIELECTRIC

Polypropylene film

ELECTRODES

Metallized film

FEATURES

10 to 27.5 mm lead pitch. Supplied loose in box, taped on reel

RoHS compliant product

CONSTRUCTION

Mono construction

RATED VOLTAGE

AC 310 V; 50 to 60 Hz

PERMISSIBLE DC VOLTAGE

DC 630 V

ENCAPSULATION

Plastic case, epoxy resin sealed, flame retardant UL-class 94 V-0

CLIMATIC TESTING CLASS ACC. TO IEC 60068-1

55/110/56/B

CAPACITANCE RANGE (E12 SERIES)

E12 series 0.001 to 2.2 μ F

Preferred values acc. to E6

CAPACITANCE TOLERANCE

$\pm 20\%$; $\pm 10\%$; $\pm 5\%$

LEADS

Tinned wire

MAXIMUM APPLICATION TEMPERATURE

$C \leq 470$ nF: 110 °C (125 °C for less than 1000 h)

$C > 470$ nF: 110 °C

DETAIL SPECIFICATION

For more detailed data and test requirements, contact:

RFI@vishay.com



RoHS
COMPLIANT



COMPOSITION OF CATALOG NUMBER

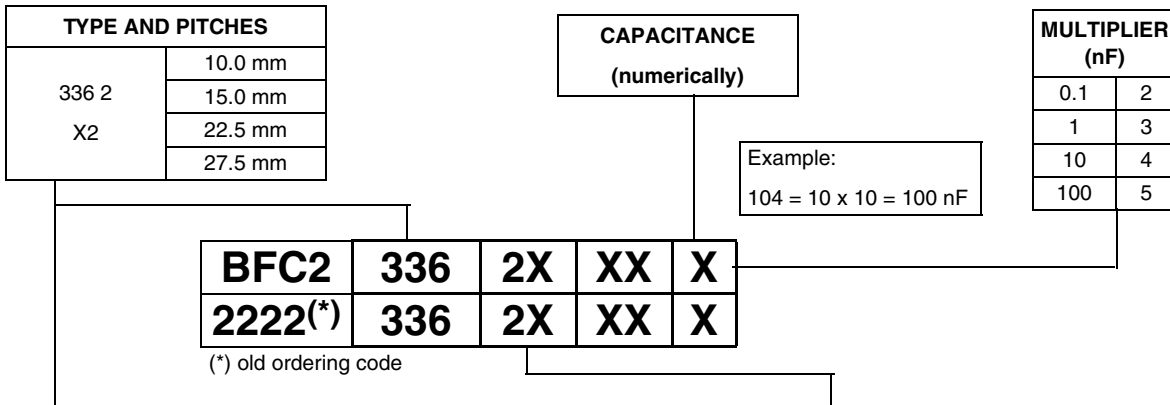

TYPE	PACKAGING	STANDARD DIMENSIONS	C-TOL	CODE NUMBER	
336 2 X2	Loose in box	Lead length 3.5 + 1/-0.5 mm or 3.5 ± 0.3 mm	± 20 %	BFC2 336 20...	
		Lead length 5.0 ± 1.0 mm		See tables	
		Lead length 25.0 ± 2.0 mm		BFC2 336 26...	
	Taped on reel ⁽¹⁾	H = 18.5 mm; P ₀ = 12.7 mm		BFC2 336 23...	
	Loose in box	Loose in box	Lead length 3.5 + 1/-0.5 mm or 3.5 ± 0.3 mm	± 10 %	BFC2 336 21...
			Lead length 5.0 ± 1.0 mm		See tables
			Lead length 25.0 ± 2.0 mm		BFC2 336 27...
	Taped on reel ⁽¹⁾	H = 18.5 mm; P ₀ = 12.7 mm		BFC2 336 24...	
	Loose in box	Loose in box	Lead length 3.5 + 1/-0.5 mm or 3.5 ± 0.3 mm	± 5 %	BFC2 336 22...
			Lead length 5.0 ± 1.0 mm		See tables
			Lead length 25.0 ± 2.0 mm		BFC2 336 28...
	Taped on reel	H = 18.5 mm; P ₀ = 12.7 mm		BFC2 336 25...	
		PACKAGING	ALTERNATIVE LARGER PITCH SIZES	C-TOL	CODE NUMBER
	Loose in box	Loose in box	Lead length 3.5 + 1/-0.5 mm or 3.5 ± 0.3 mm	± 20 %	See tables for details
Lead length 5.0 ± 1.0 mm					
Lead length 25.0 ± 2.0 mm					
Taped on reel ⁽¹⁾	H = 18.5 mm; P ₀ = 12.7 mm				
Loose in box	Loose in box	Lead length 3.5 + 1/-0.5 mm or 3.5 ± 0.3 mm	± 10 %		
		Lead length 5.0 ± 1.0 mm			
		Lead length 25.0 ± 2.0 mm			
Taped on reel ⁽¹⁾	H = 18.5 mm P ₀ = 12.7 mm				

Notes

(1) For detailed tape specifications refer to "Packaging Information": www.vishay.com/docs/28139/packinfo.pdf

(2) SPQ = Standard Packaging Quantity



SPECIFIC REFERENCE DATA

DESCRIPTION	VALUE
Rated AC voltage U_{Rac}	310 V
Permissible DC voltage U_{Rdc}	630 V
Tangent of loss angle:	at 1 kHz at 10 kHz
$C < 470 \text{ nF}$	$\leq 10 \times 10^{-4}$ $\leq 20 \times 10^{-4}$
$470 \text{ nF} \leq C \leq 1 \mu\text{F}$	$\leq 20 \times 10^{-4}$ $\leq 70 \times 10^{-4}$
$C > 1 \mu\text{F}$	$\leq 30 \times 10^{-4}$ -
Rated voltage pulse slope $(dU/dt)_R$ at 435 Vdc	100 V/ μs
R between leads, for $C \leq 0.33 \mu\text{F}$ at 100 V; 1 min	$> 15\,000 \text{ M}\Omega$
RC between leads, for $C > 0.33 \mu\text{F}$ at 100 V; 1 min	$> 5000 \text{ s}$
R between leads and case; 100 V; 1 min	$> 30\,000 \text{ M}\Omega$
Withstanding (DC) voltage (cut off current 10 mA); rise time 100 V/s:	
$C \leq 1 \mu\text{F}$	2200 V; 1 min
$C > 1 \mu\text{F}$	1800 V; 1 min
Withstanding (AC) voltage between leads and case	2120 V; 1 min
Max. application temperature for $0.001 \mu\text{F} \leq C \leq 0.47 \mu\text{F}$	110 °C (125 °C for less than 1000 h)
Max. application temperature for $C > 0.47 \mu\text{F}$	110 °C

PITCH: 10.0 mm; C-TOL = $\pm 20 \%$

C (μF)	DIMENSIONS w x h x l (mm)	MASS (g) ⁽³⁾	CATALOG NUMBER BFC2 336 AND PACKAGING									
			LOOSE IN BOX					REEL (500 mm) ^{(1) (2)}				
			SHORT LEADS			LONG LEADS		H = 18.5 mm P ₀ = 12.7 mm				
			$l_t = 3.5 + 1/-0.5 \text{ mm}$	$l_t = 5.0 \pm 1.0 \text{ mm}$	SPQ	$l_t = 25.0 \pm 2.0 \text{ mm}$	SPQ		SPQ			
Pitch: 10.0 mm \pm 0.4 mm; d_t = 0.6 mm \pm 0.06 mm												
0.001	4.0 x 10.0 x 12.5	0.6	20102	29131	1000	26102	1250	23102	1400			
0.0015			20152	29132		26152		23152				
0.0022			20222	29133		26222		23222				
0.0033			20332	29134		26332	1000	23332		1100		
0.0047			20472	29135		26472		23472				
0.0068			20682	29136		26682		23682				
0.01			20103	29137		26103		23103				
0.015			20153	29138		26153		23153				
0.022			20223	29139		26223		23223				
0.033			20333	29141		750	26333	750			23333	900

Notes

- (1) H = in-tape height; P₀ = sprocket hole distance; for detailed specifications refer to "Packaging Information"
- (2) Reel diameter = 356 mm is available on request
- (3) Weight for short lead product only

MKP 336 2 X2

Vishay BCcomponents Interference Suppression Film Capacitors
MKP Radial Potted Type



PITCH: 10.0 mm; C-TOL = ± 10 %

C (µF)	DIMENSIONS w x h x l (mm)	MASS (g) ⁽³⁾	CATALOG NUMBER BFC2 336 AND PACKAGING						
			LOOSE IN BOX					REEL (500 mm) ^{(1) (2)}	
			SHORT LEADS			LONG LEADS		H = 18.5 mm P ₀ = 12.7 mm	
			l _t = 3.5 + 1/-0.5 mm	l _t = 5.0 ± 1.0 mm	SPQ	l _t = 25.0 ± 2.0 mm	SPQ		SPQ
0.001	4.0 x 10.0 x 12.5	0.6	21102	29154		27102		24102	
0.0012			21122	-		27122		24122	
0.0015			21152	29155		27152	1250	24152	1400
0.0018			21182	-		27182		24182	
0.0022			21222	29156		27222		24222	
0.0027			21272	-		27272		24272	
0.0033			21332	29157		27332		24332	
0.0039			21392	-		27392		24392	
0.0047			21472	29158	1000	27472		24472	
0.0056			21562	-		27562		24562	
0.0068			21682	29159		27682	1000	24682	1100
0.0082			21822	-		27822		24822	
0.01			21103	29161		27103		24103	
0.012			21123	-		27123		24123	
0.015			21153	29162		27153		24153	
0.018			21183	-		27183		24183	
0.022			21223	29163		27223		24223	
0.027			21273	-	750	27273	750	24273	900
0.033			21333	29164		27333		24333	

Notes

⁽¹⁾ H = in-tape height; P₀ = sprocket hole distance; for detailed specifications refer to "Packaging Information"

⁽²⁾ Reel diameter = 356 mm is available on request

⁽³⁾ Weight for short lead product only



PITCH: 10.0 mm; C-TOL = ± 5 %

C (μ F)	DIMENSIONS w x h x l (mm)	MASS (g) ⁽³⁾	CATALOG NUMBER BFC2 336 AND PACKAGING						
			LOOSE IN BOX					REEL (500 mm) ^{(1) (2)}	
			SHORT LEADS			LONG LEADS		H = 18.5 mm P ₀ = 12.7 mm	
			l _t = 3.5 + 1/-0.5 mm	l _t = 5.0 ± 1.0 mm	SPQ	l _t = 25.0 ± 2.0 mm	SPQ		SPQ
0.001	4.0 x 10.0 x 12.5	0.6	22102	-		28102		25102	
0.0012			22122	-		28122		25122	
0.0015			22152	-		28152	1250	25152	1400
0.0018			22182	-		28182		25182	
0.0022			22222	-		28222		25222	
0.0027			22272	-		28272		25272	
0.0033			22332	-		28332		25332	
0.0039			22392	-		28392		25392	
0.0047			22472	-	1000	28472		25472	
0.0056			22562	-		28562		25562	
0.0068			22682	-		28682	1000	25682	1100
0.0082			22822	-		28822		25822	
0.01			22103	-		28103		25103	
0.012			22123	-		28123		25123	
0.015			22153	-		28153		25153	
0.018			22183	-		28183		25183	
0.022			22223	-		28223		25223	
0.027			22273	-	750	28273	750	25273	900
0.033			22333	-		28333		25333	

Notes

- (1) H = in-tape height; P₀ = sprocket hole distance; for detailed specifications refer to "Packaging Information"
- (2) Reel diameter = 356 mm is available on request
- (3) Weight for short lead product only

MKP 336 2 X2

Vishay BCcomponents Interference Suppression Film Capacitors
MKP Radial Potted Type



PITCH: 15.0 mm; C-TOL = ± 20 %

C (µF)	DIMENSIONS w x h x l (mm)	MASS (g) ⁽³⁾	CATALOG NUMBER BFC2 336 AND PACKAGING						
			LOOSE IN BOX					REEL (500 mm) ^{(1) (2)}	
			SHORT LEADS			LONG LEADS		H = 18.5 mm P ₀ = 12.7 mm	
			l _t = 3.5 ± 0.3 mm	l _t = 5.0 ± 1.0 mm	SPQ	l _t = 25.0 ± 2.0 mm	SPQ		SPQ
Pitch = 15 ± 0.4 mm; d_t = 0.60 ± 0.06 mm									
0.01	5.0 x 11.0 x 17.5	0.98	29001	29273	1000	29097	1000	29004	1100
0.015			29011	29274		29071		29014	
0.022			29021	29275		29076		29024	
0.033			29031	29276		29082		29034	
0.047			20473	29142		26473		23473	
0.068			20683	29143		26683		23683	
0.1			20104	29144		26104		23104	900
0.15	6.0 x 12.0 x 17.5	1.4	20154	29145		26154	500	23154	650
Pitch = 15 ± 0.4 mm; d_t = 0.80 ± 0.08 mm									
0.22	7.0 x 13.5 x 17.5	1.8	20224	29146	500	26224	500	23224	600

Notes

- (1) H = in-tape height; P₀ = sprocket hole distance; for detailed specifications refer to "Packaging Information"
- (2) Reel diameter = 356 mm is available on request
- (3) Weight for short lead product only

PITCH: 15.0 mm; C-TOL = ± 10 %

C (µF)	DIMENSIONS w x h x l (mm)	MASS (g) ⁽³⁾	CATALOG NUMBER BFC2 336 AND PACKAGING							
			LOOSE IN BOX					REEL (500 mm) ^{(1) (2)}		
			SHORT LEADS			LONG LEADS		H = 18.5 mm P ₀ = 12.7 mm		
			l _t = 3.5 ± 0.3 mm	l _t = 5.0 ± 1.0 mm	SPQ	l _t = 25.0 ± 2.0 mm	SPQ		SPQ	
Pitch = 15 ± 0.4 mm; d_t = 0.60 ± 0.06 mm										
0.01	5.0 x 11.0 x 17.5	0.98	29002	29281	1000	29066	1000	29005	1100	
0.012			29007	-		29068		29009		
0.015			29012	29282		29072		29015		
0.018			29017	-		29074		29019		
0.022			29022	29283		29077		29025		
0.027			29027	-		29079		29029		
0.033			29032	29284		29083		29035		
0.039			21393	-		27393		24393		
0.047			21473	29165		27473		24473		
0.056			21563	-		27563		24563		
0.068			21683	29166		27683		24683		900
0.082			21823	-		27823		24823		
0.1			21104	29167		27104		24104		800
0.12			6.0 x 12.0 x 17.5	1.4		21124		-		27124
0.15	21154	29168			27154	24154				
Pitch = 15 ± 0.4 mm; d_t = 0.80 ± 0.08 mm										
0.18	7.0 x 13.5 x 17.5	1.8	21184	-	27184		24184			
0.22			21224	29169	500	27224	500	24224	600	

Notes

- (1) H = in-tape height; P₀ = sprocket hole distance; for detailed specifications refer to "Packaging Information"
- (2) Reel diameter = 356 mm is available on request
- (3) Weight for short lead product only



PITCH: 15.0 mm; C-TOL = ± 5 %

C (µF)	DIMENSIONS w x h x l (mm)	MASS (g) ⁽³⁾	CATALOG NUMBER BFC2 336 AND PACKAGING						
			LOOSE IN BOX					REEL (500 mm) ^{(1) (2)}	
			SHORT LEADS			LONG LEADS		H = 18.5 mm P ₀ = 12.7 mm	
			l _t = 3.5 ± 0.3 mm	l _t = 5.0 ± 1.0 mm	SPQ	l _t = 25.0 ± 2.0 mm	SPQ		SPQ
Pitch = 15 ± 0.4 mm; d_t = 0.60 ± 0.06 mm									
0.01	5.0 x 11.0 x 17.5	0.98	29003	-	1000	29067	1000	29006	1100
0.012			29008	-		29069		29061	
0.015			29013	-		29073		29016	
0.018			29018	-		29075		29062	
0.022			29023	-		29078		29026	
0.027			29028	-		29081		29063	
0.033			29033	-		29084		29036	
0.039			22393	-		28393		25393	
0.047			22473	-		28473		25473	
0.056			22563	-		28563		25563	
0.068	6.0 x 12.0 x 17.5	1.4	22683	-	500	28683	500	25683	900
0.082			22823	-		28823		25823	
0.1			22104	-		28104		25104	
0.12	6.0 x 12.0 x 17.5	1.4	22124	-	500	28124	500	25124	650
0.15			22154	-		28154		25154	
Pitch = 15 ± 0.4 mm; d_t = 0.80 ± 0.08 mm									
0.18	7.0 x 13.5 x 17.5	1.8	22184	-	500	28184	500	25184	600

Notes

- (1) H = in-tape height; P₀ = sprocket hole distance; for detailed specifications refer to “Packaging Information”
- (2) Reel diameter = 356 mm is available on request
- (3) Weight for short lead product only

PITCH: 22.5 mm; C-TOL = ± 20 %

C (µF)	DIMENSIONS w x h x l (mm)	MASS (g) ⁽³⁾	CATALOG NUMBER BFC2 336 AND PACKAGING						
			LOOSE IN BOX					REEL (500 mm) ^{(1) (2)}	
			SHORT LEADS			LONG LEADS		H = 18.5 mm P ₀ = 12.7 mm	
			l _t = 3.5 ± 0.3 mm	l _t = 5.0 ± 1.0 mm	SPQ	l _t = 25.0 ± 2.0 mm	SPQ		SPQ
Pitch = 22.5 ± 0.4 mm; d_t = 0.80 ± 0.08 mm									
0.15	6.0 x 15.5 x 26.0	2.4	29041	29277	300	29087	500	29044	600
0.22			29051	29278		29093		29053	550
0.33			20334	29147		26334		23334	450
0.47	7.0 x 16.5 x 26.0	2.9	20474	29148	200	26474	500	23474	400

Notes

- (1) H = in-tape height; P₀ = sprocket hole distance; for detailed specifications refer to “Packaging Information”
- (2) Reel diameter = 356 mm is available on request
- (3) Weight for short lead product only

MKP 336 2 X2

Vishay BCcomponents Interference Suppression Film Capacitors
MKP Radial Potted Type



PITCH: 22.5 mm; C-TOL = ± 10 %

C (µF)	DIMENSIONS w x h x l (mm)	MASS (g) ⁽³⁾	CATALOG NUMBER BFC2 336 AND PACKAGING						
			LOOSE IN BOX					REEL (500 mm) ^{(1) (2)}	
			SHORT LEADS			LONG LEADS		H = 18.5 mm P ₀ = 12.7 mm	
			l _t = 3.5 ± 0.3 mm	l _t = 5.0 ± 1.0 mm	SPQ	l _t = 25.0 ± 2.0 mm	SPQ		SPQ
Pitch = 22.5 ± 0.4 mm; d_t = 0.80 ± 0.08 mm									
0.12	6.0 x 15.5 x 26.0	2.4	29037	-	300	29085	500	29039	600
0.15			29042	29285		29088		29045	
0.18			29047	-		29091		29049	
0.22			29052	29286		29094		29054	
0.27			21274	-		27274		24274	
0.33	7.0 x 16.5 x 26.0	2.9	21334	29171	200	27334	500	24334	450
0.39			21394	-		27394		24394	
0.47			21474	29172		27474		24474	400

Notes

- (1) H = in-tape height; P₀ = sprocket hole distance; for detailed specifications refer to "Packaging Information"
- (2) Reel diameter = 356 mm is available on request
- (3) Weight for short lead product only

PITCH: 22.5 mm; C-TOL = ± 5 %

C (µF)	DIMENSIONS w x h x l (mm)	MASS (g) ⁽³⁾	CATALOG NUMBER BFC2 336 AND PACKAGING						
			LOOSE IN BOX					REEL (500 mm) ^{(1) (2)}	
			SHORT LEADS			LONG LEADS		H = 18.5 mm P ₀ = 12.7 mm	
			l _t = 3.5 ± 0.3 mm	l _t = 5.0 ± 1.0 mm	SPQ	l _t = 25.0 ± 2.0 mm	SPQ		SPQ
Pitch = 22.5 ± 0.4 mm; d_t = 0.80 ± 0.08 mm									
0.12	6.0 x 15.5 x 26.0	2.4	29038	-	300	29086	500	29064	600
0.15			29043	-		29089		29046	
0.18			29048	-		29092		29065	
0.22			22224	-		28224		25224	
0.27			22274	-		28274		25274	
0.33	7.0 x 16.5 x 26.0	2.9	22334	-	200	28334	500	25334	450
0.39			22394	-		28394		25394	

Notes

- (1) H = in-tape height; P₀ = sprocket hole distance; for detailed specifications refer to "Packaging Information"
- (2) Reel diameter = 356 mm is available on request
- (3) Weight for short lead product only



PITCH: 27.5 mm; C-TOL = ± 20 %

C (µF)	DIMENSIONS w x h x l (mm)	MASS (g) ⁽¹⁾	CATALOG NUMBER BFC 2336 AND PACKAGING				
			LOOSE IN BOX				
			SHORT LEADS			LONG LEADS	
			l _t = 3.5 ± 0.3 mm	l _t = 5.0 ± 1.0 mm	SPQ	l _t = 25.0 ± 2.0 mm	SPQ
Pitch = 27.5 ± 0.4 mm; d _t = 0.80 ± 0.08 mm							
0.47	9.0 x 19.0 x 31.0	5.5	29055	29279	100	29095	150
0.68			20684	29149	100	26684	125
1.0	11.0 x 21.0 x 31.0	7.4	20105	29151	100	26105	125
1.5	13.0 x 23.0 x 31.0	9.2	20155	29152	100	26155	125
2.2	15.0 x 25.0 x 31.0	12.3	20225	29153	100	26225	75

Note

⁽¹⁾ Weight for short lead product only

PITCH: 27.5 MM; C-TOL = ± 10 %

C (µF)	DIMENSIONS w x h x l (mm)	MASS (g) ⁽¹⁾	CATALOG NUMBER BFC2 336 AND PACKAGING				
			LOOSE IN BOX				
			SHORT LEADS			LONG LEADS	
			l _t = 3.5 ± 0.3 mm	l _t = 5.0 ± 1.0 mm	SPQ	l _t = 25.0 ± 2.0 mm	SPQ
Pitch = 27.5 ± 0.4 mm; d _t = 0.80 ± 0.08 mm							
0.47	9.0 x 19.0 x 31.0	5.5	29056	29287	100	29096	150
0.56			21564	-		27564	125
0.68			21684	29173		27684	
0.82	11.0 x 21.0 x 31.0	7.4	21824	-	100	27824	125
1.0			21105	29174		27105	
1.2	13.0 x 23.0 x 31.0	9.2	21125	-		27125	75
1.5			21155	29175		27155	
1.8	15.0 x 25.0 x 31.0	12.3	21185	-	100	27185	75
2.2			21225	29176		27225	

Note

⁽¹⁾ Weight for short lead product only

PITCH: 27.5 mm; C-TOL = ± 5 %

C (µF)	DIMENSIONS w x h x l (mm)	MASS (g) ⁽¹⁾	CATALOG NUMBER BFC2 336 AND PACKAGING				
			LOOSE IN BOX				
			SHORT LEADS			LONG LEADS	
			l _t = 3.5 ± 0.3 mm	l _t = 5.0 ± 1.0 mm	SPQ	l _t = 25.0 ± 2.0 mm	SPQ
Pitch = 27.5 ± 0.4 mm; d _t = 0.80 ± 0.08 mm							
0.47	9.0 x 19.0 x 31.0	5.5	22474	-	100	28474	125
0.56			22564	-		28564	
0.68			22684	-		28684	
0.82	11.0 x 21.0 x 31.0	7.4	22824	-	100	28824	125
1.0			22105	-		28105	
1.2	13.0 x 23.0 x 31.0	9.2	22125	-		28125	75
1.5			22155	-		28155	
1.8	15.0 x 25.0 x 31.0	12.3	22185	-	100	28185	75
2.2			22225	-		28225	





Note

⁽¹⁾ Weight for short lead product only

APPROVALS

SAFETY APPROVALS X2	VOLTAGE	VALUE	FILE NUMBERS
EN 60384-14 ed 3 (ENEC) (= IEC 60384-14 ed 3)	310 Vac	1 nF to 2.2 μF	FI 2008038
UL1414 and CSA-C22.2 No. 1	250 Vac	1 nF to 1 μF	E112471
UL1283	305 Vac	1 nF to 2.2 μF	E109565
CSA-E 384-14	310 Vac	1 nF to 2.2 μF	Pending
CQC	310 Vac	1 nF to 2.2 μF	CQC07001021280 (L)
			CQC04001009254 (S)
			CQC04001009262 (F)
CB Test Certificate	310 Vac	1 nF to 2.2 μF	FI 5123

The EneC-approval together with the CB-Certificate replace all national marks of the following countries (they have already signed the ENEC-Agreement): Austria; Belgium; Czech. Republic; Denmark; Finland; France; Germany; Greece; Hungary; Ireland; Italy; Luxembourg; Netherlands; Norway; Portugal; Slovenian; Spain; Sweden; Switzerland and United Kingdom.

MOUNTING

Normal Use

The capacitors are designed for mounting on printed -circuit boards. The capacitors packed in bandoliers are designed for mounting in pintoed-circuit boards by means of automatic insertion machines. For detailed tape specifications refer to "Packaging information": www.vishay.com/docs/28139/packinfo.pdf.

Specific Method of Mounting to Withstand Vibration and Shock

In order to withstand vibration and shock tests, it must be insured that the stand-off pins are in good contact with the printed circuit board:

- For pitches ≤ 15 mm capacitors shall be mechanically fixed by the leads
- For larger pitches the capacitors shall be mounted in the same way and the body clamped.

Space Requirements on Printed Circuit Board

The maximum length and width of film capacitors is shown in the figure:

- Eccentricity as in drawing. The maximum eccentricity is smaller than or equal to lead diameter of the product concerned
- Product height with seating plane as given by "IEC 60717" as reference height: $h_{max.} \leq h + 0.3$ mm or $h_{max.} \leq h' + 0.3$ mm

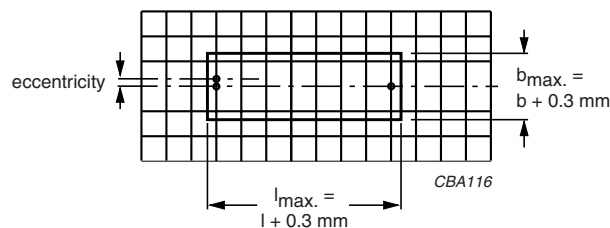

Storage Temperature

- Storage temperature: $T_{stg} = -25$ to $+40$ °C with RH maximum 80 % without condensation

Ratings and Characteristics Reference Conditions

Unless otherwise specified, all electrical values apply to an ambient temperature of 23 ± 1 °C, an atmospheric pressure of 86 kPa to 106 kPa and a relative humidity of 50 ± 2 %.

For reference testing, a conditioning period shall be applied over 96 ± 4 hours by heating the products in a circulating air oven at the rated temperature and a relative humidity not exceeding 20 %.



CHARACTERISTICS

Capacitance as a function of ambient temperature (typical curve)

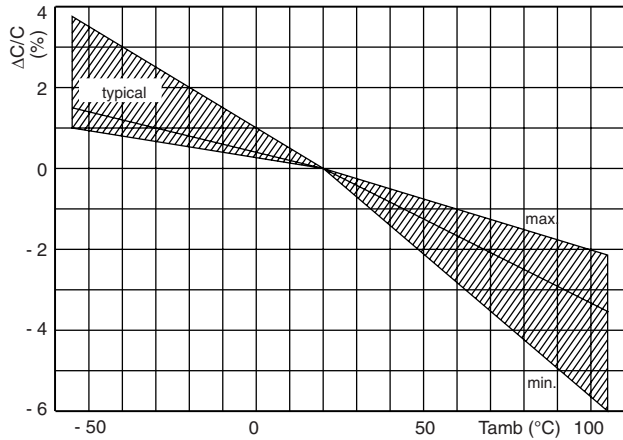

Impedance as a function of frequency (typical curve)

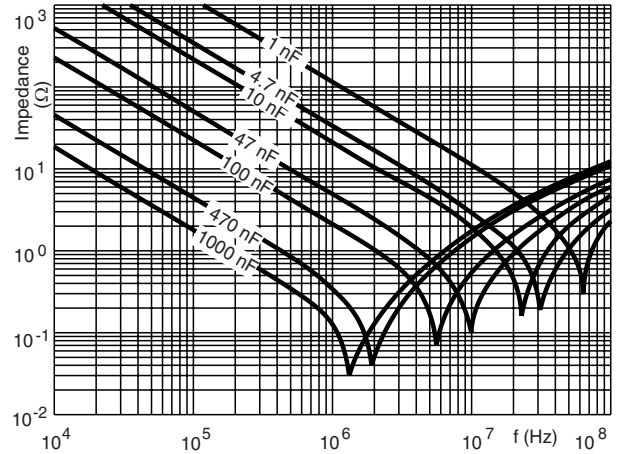

Tangent of loss angle as a function of frequency (typical curve)

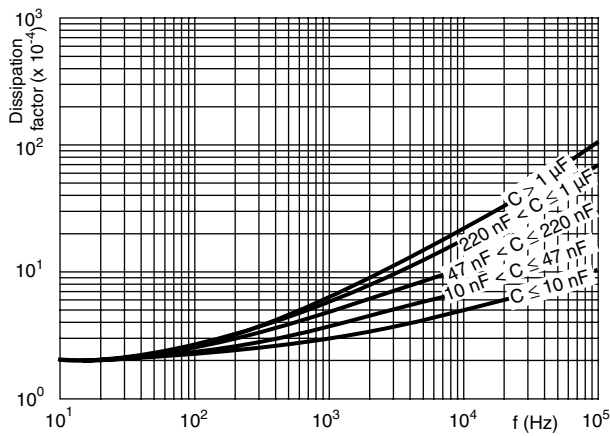

Resonant frequency as a function of capacitance (typical curve)

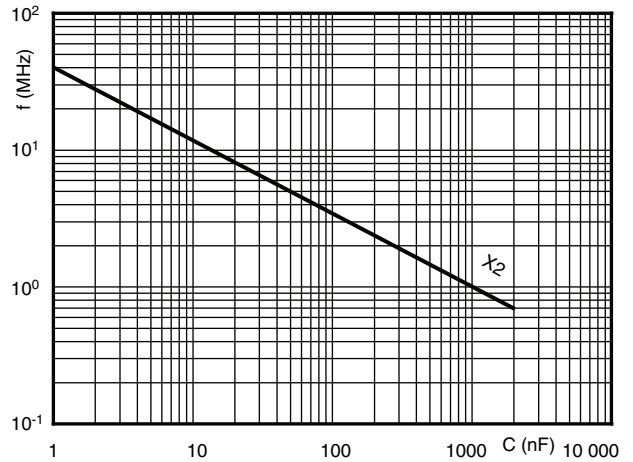

Max. RMS voltage as a function of frequency (typical curve)

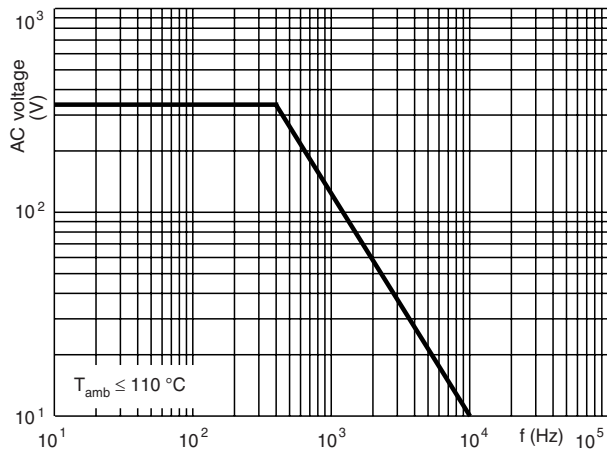

Max. RMS current as a function of frequency (typical curve)

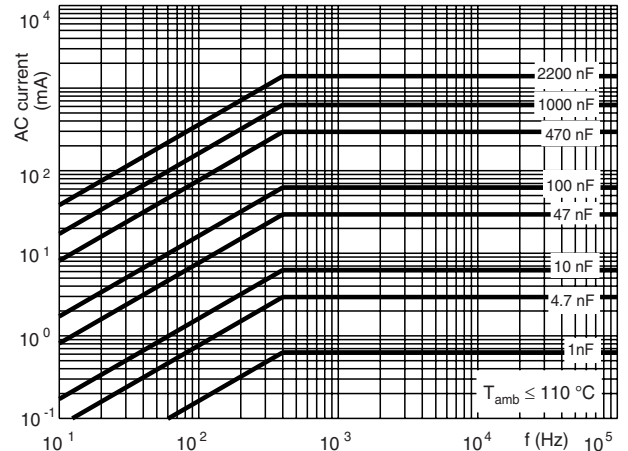

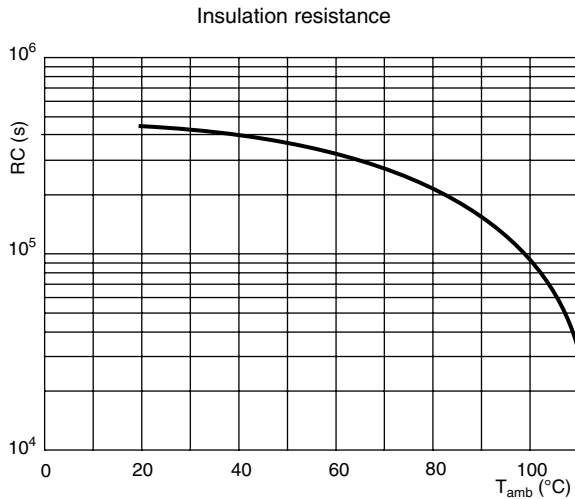

APPLICATION NOTES

- For X2 electromagnetic interference suppression in **standard across the line applications** (50/60 Hz) with a maximum mains voltage of 310 Vac
- For series impedance applications we refer to the application note www.vishay.com/docs/28153/anaccaps.pdf
- These capacitors are not intended for continuous pulse applications. For these situations, capacitors of the AC and pulse programs must be used.
- The maximum ambient temperature must not exceed 110 °C (125 °C for less than 1000 h) for $C \leq 470$ nF and 110 °C for $C > 470$ nF
- Rated voltage pulse slope:
If the pulse voltage is lower than the rated voltage, the values of the specific reference data can be multiplied by 435 Vdc and divided by the applied voltage

INSPECTION REQUIREMENTS

GENERAL NOTES

Sub-clause numbers of tests and performance requirements refer to the “Sectional Specification, IEC publication IEC 60384-14 ed 3 and Specific Reference Data”.

Group C inspection requirements

SUB-CLAUSE NUMBER AND TEST	CONDITIONS	PERFORMANCE REQUIREMENTS
SUB-GROUP C1A PART OF SAMPLE OF SUB-GROUP C1		
4.1 Dimensions (detail)		As specified in chapters “General Data” of this specification
Initial measurements	Capacitance Tangent of loss angle: For $C \leq 1$ μ F at 10 kHz For $C > 1$ μ F at 1 kHz	
4.3 Robustness of terminations	Tensile: Load 10 N; 10 s Bending: Load 5 N; 4 x 90°	No visible damage



SUB-CLAUSE NUMBER AND TEST	CONDITIONS	PERFORMANCE REQUIREMENTS
4.9.2 Final measurements	Visual examination Capacitance Tangent of loss angle Insulation resistance	No visible damage $ \Delta C/C \leq 5\%$ of the value measured initially. Increase of $\tan \delta$: ≤ 0.008 for: $C \leq 1 \mu\text{F}$ or ≤ 0.005 for: $C > 1 \mu\text{F}$ Compared to values measured initially As specified in section "Insulation Resistance" of this specification
SUB-GROUP C1 COMBINED SAMPLE OF SPECIMENS OF SUB-GROUPS C1A AND C1B		
4.11 Climatic sequence 4.11.1 Initial measurements 4.11.2 Dry heat 4.11.3 Damp heat cyclic Test Db First cycle 4.11.4 Cold 4.11.5 Damp heat cyclic Test Db remaining cycles 4.11.6 Final measurements	Capacitance Measured in 4.4.2 and 4.9.2 Tangent of loss angle: Measured initially in C1A and C1B Temperature: 110 °C Duration: 16 h Temperature: - 55 °C Duration: 2 h Visual examination Capacitance Tangent of loss angle Voltage proof 1350 Vdc; 1 min between terminations Insulation resistance	No visible damage Legible marking $ \Delta C/C \leq 5\%$ of the value measured in 4.11.1. Increase of $\tan \delta$: ≤ 0.008 for: $C \leq 1 \mu\text{F}$ or ≤ 0.005 for: $C > 1 \mu\text{F}$ Compared to values measured in 4.11.1. No permanent breakdown or flash-over $\geq 50\%$ of values specified in section "Insulation Resistance" of this specification

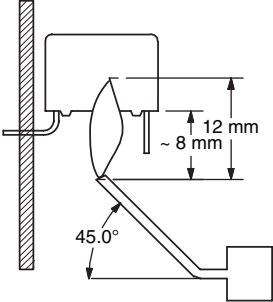

SUB-CLAUSE NUMBER AND TEST	CONDITIONS	PERFORMANCE REQUIREMENTS
SUB GROUP C2		
4.12 Damp heat steady state 4.12.1 Initial measurements 4.12.3 Final measurements	56 days, 40 °C, 90 to 95 % RH No load Capacitance Tangent of loss angle at 1 kHz Visual examination Capacitance Tangent of loss angle Voltage proof 1350 Vdc; 1 min between terminations Insulation resistance	No visible damage Legible marking $ \Delta C/C \leq 5\%$ of the value measured in 4.12.1. Increase of tan δ : ≤ 0.008 for: $C \leq 1 \mu\text{F}$ or ≤ 0.005 for: $C > 1 \mu\text{F}$ Compared to values measured in 4.12.1. No permanent breakdown or flash-over $\geq 50\%$ of values specified in section "Insulation Resistance" of this specification
SUB-GROUP C3		
4.13.1 Initial measurements 4.13 Impulse voltage 4.14 Endurance 4.14.7 Final measurements	Capacitance Tangent of loss angle: For $C \leq 1 \mu\text{F}$ at 10 kHz For $C > 1 \mu\text{F}$ at 1 kHz 3 successive impulses, full wave, peak voltage: 2.5 kV for $C \leq 1 \mu\text{F}$ 2.5 kV/ \sqrt{C} for $C > 1 \mu\text{F}$ Max. 24 pulses Duration: 1000 h 1.25 x U_{Rac} at 110 °C Once in every hour the voltage is increased to 1000 V_{rms} for 0.1 s via resistor of $47 \Omega \pm 5\%$ Visual examination Capacitance Tangent of loss angle Voltage proof 1350 Vdc; 1 min between terminations 2120 Vac; 1 min between terminations and case Insulation resistance	No selfhealing breakdowns or flashover No visible damage Legible marking $ \Delta C/C \leq 10\%$ compared to values measured in 4.13.1. Increase of tan δ : ≤ 0.008 for: $C \leq 1 \mu\text{F}$ or ≤ 0.005 for: $C > 1 \mu\text{F}$ Compared to values measured in 4.13.1. No permanent breakdown or flash-over $\geq 50\%$ of values specified in section "Insulation Resistance" of this specification

SUB-CLAUSE NUMBER AND TEST	CONDITIONS	PERFORMANCE REQUIREMENTS
SUB-GROUP C4		
<p>4.15 Charge and discharge</p> <p>4.15.1 Initial measurements</p> <p>4.15.3 Final measurements</p>	<p>10 000 cycles Charged to 435 Vdc Discharge resistance:</p> $R = \frac{435 \text{ Vdc}}{1.25 \times C (dU/dt)}$ <p>Capacitance Tangent of loss angle: For $C \leq 1 \mu\text{F}$ at 10 kHz For $C > 1 \mu\text{F}$ at 1 kHz</p> <p>Capacitance</p> <p>Tangent of loss angle</p> <p>Insulation resistance</p>	<p>$\Delta C/C \leq 10\%$ compared to values measured in 4.15.1.</p> <p>Increase of $\tan \delta$: ≤ 0.008 for: $C \leq 1 \mu\text{F}$ or ≤ 0.005 for: $C > 1 \mu\text{F}$</p> <p>Compared to values measured in 4.15.1.</p> <p>$\geq 50\%$ of values specified in section "Insulation Resistance" of this specification</p>
SUB-GROUP C5		
4.16 Radio frequency characteristic	Resonance frequency	≥ 0.9 times the value as specified in section "Resonant Frequency" of this specification
SUB-GROUP C6		
4.17 Passive flammability Class B	<p>Bore of gas jet: $\varnothing 0.5 \text{ mm}$ Fuel: Butane Test duration for actual volume V in mm^3: $V \leq 250$: 10 s $250 < V \leq 500$: 20 s $500 < V \leq 1750$: 30 s $V > 1750$: 60 s One flame application</p> 	After removing test flame from capacitor, the capacitor must not continue to burn for more than 10 s. No burning particle must drop from the sample.
SUB-GROUP C7		
4.18 Active flammability	20 cycles of 2.5 kV discharges on the test capacitor connected to U_{Rac}	The cheese cloth around the capacitors shall not burn with a flame. No electrical measurements are required.



Disclaimer

All product specifications and data are subject to change without notice.

Vishay Intertechnology, Inc., its affiliates, agents, and employees, and all persons acting on its or their behalf (collectively, "Vishay"), disclaim any and all liability for any errors, inaccuracies or incompleteness contained herein or in any other disclosure relating to any product.

Vishay disclaims any and all liability arising out of the use or application of any product described herein or of any information provided herein to the maximum extent permitted by law. The product specifications do not expand or otherwise modify Vishay's terms and conditions of purchase, including but not limited to the warranty expressed therein, which apply to these products.

No license, express or implied, by estoppel or otherwise, to any intellectual property rights is granted by this document or by any conduct of Vishay.

The products shown herein are not designed for use in medical, life-saving, or life-sustaining applications unless otherwise expressly indicated. Customers using or selling Vishay products not expressly indicated for use in such applications do so entirely at their own risk and agree to fully indemnify Vishay for any damages arising or resulting from such use or sale. Please contact authorized Vishay personnel to obtain written terms and conditions regarding products designed for such applications.

Product names and markings noted herein may be trademarks of their respective owners.