



HITPOINT

TEL:8862-26013311

FAX:8862-26013898

NO.4 Lane 505, Zhongzheng Rd., Linkou Shiang, Taipei, Taiwan 24445 . R.O.C

PT-2728WQ

(RoHS)

DATE:2005.01.26

1 . Electrical Characteristics

VER :.0

Resonant Frequency (KHz)	2.8 ±0.5
Operating Voltage (Vp-p/max)	30
Rated Voltage (Vp-p)	5.0
Current Consumption (mA/max)	5.0 at Rated Voltage
Sound Pressure Level (dB/min)	80 at 10cm at Rated Voltage
Capacitance (pF)	30,000 ± 30% at 120 HZ
Operating Temperature (°C)	-20 ~ +70
Storage Temperature (°C)	-30 ~ +80
Manual soldering conditions	350±20°C / within 5sec

PS : Vp-p= 1/2duty , square wave

2 . Typical Frequency Response Curve

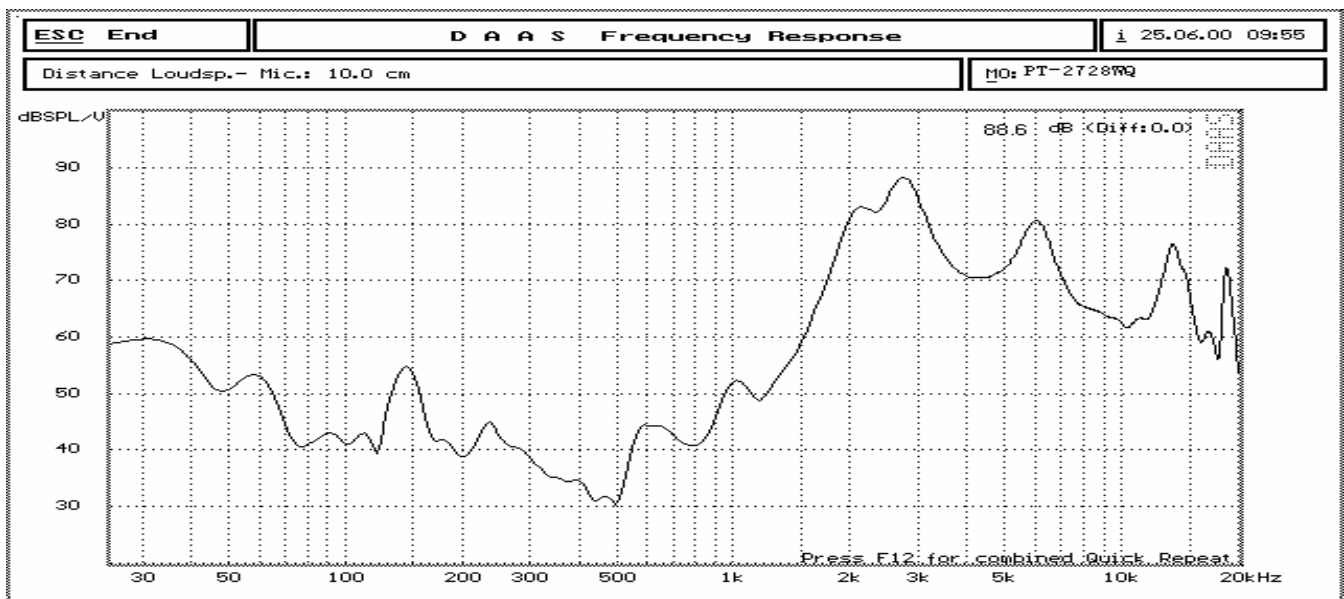

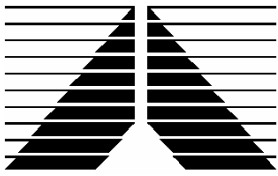

HITPOINT

TEL:8862-26013311

FAX:8862-26013898

NO.4 Lane 505, Zhongzheng Rd., Linkou Shiang, Taipei, Taiwan 24445 . R.O.C

3 . Dimensions and Material

3-1 Shape

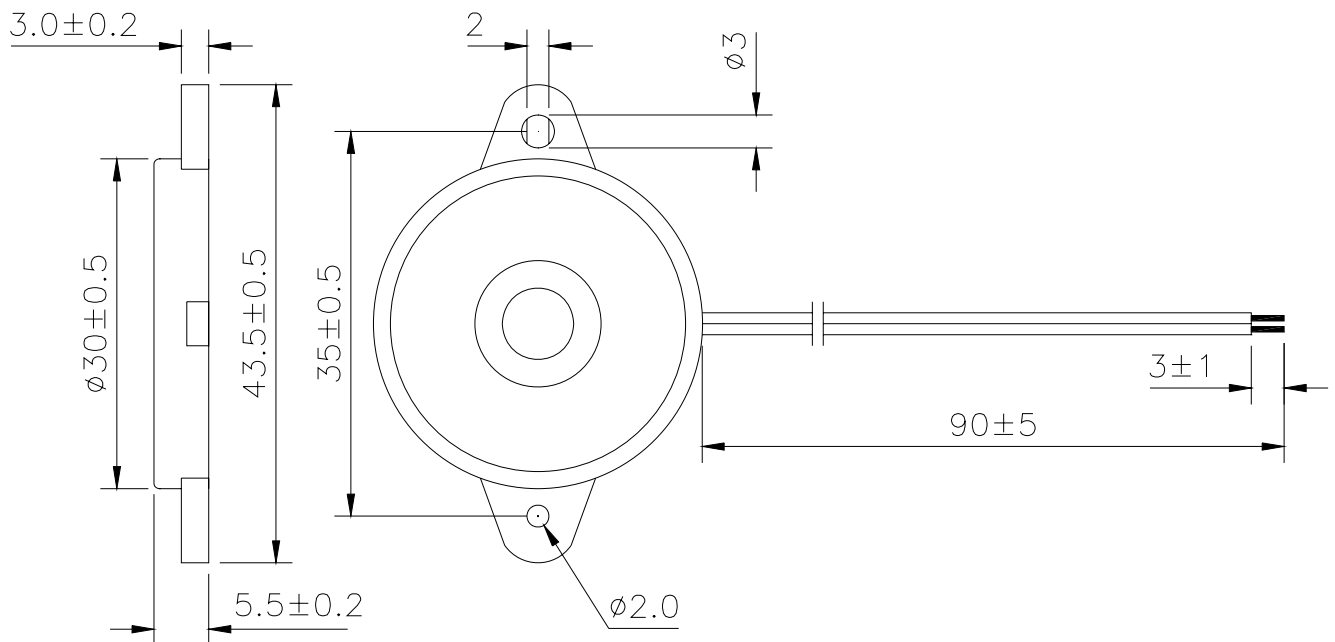

Unit:mm

3-2 Material

Housing	ABS 757 UL94HB plastic resin (Color : Black)
Leading Wire	28AWG (Red+Black)
Weight (Gram)	3.8

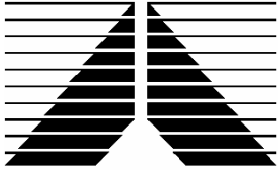

HITPOINT

TEL:8862-26013311

FAX:8862-26013898

NO.4 Lane 505, Zhongzheng Rd., Linkou Shiang, Taipei, Taiwan 24445 . R.O.C

4. TESTING METHOD

• *Standard Measurement conditions*

Temperature: 25 ± 2 °C Humidity: 45-60%

• *Acoustic Characteristics*

The oscillation frequency, current consumption and sound pressure are measured by the measuring instruments shown below.

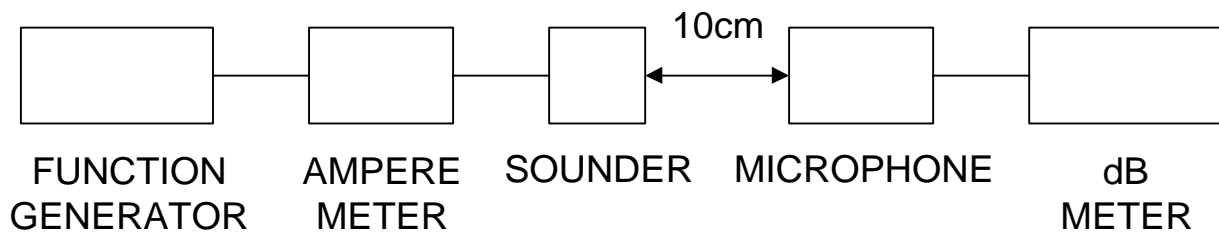

In the measuring test, buzzer is placed as follows:

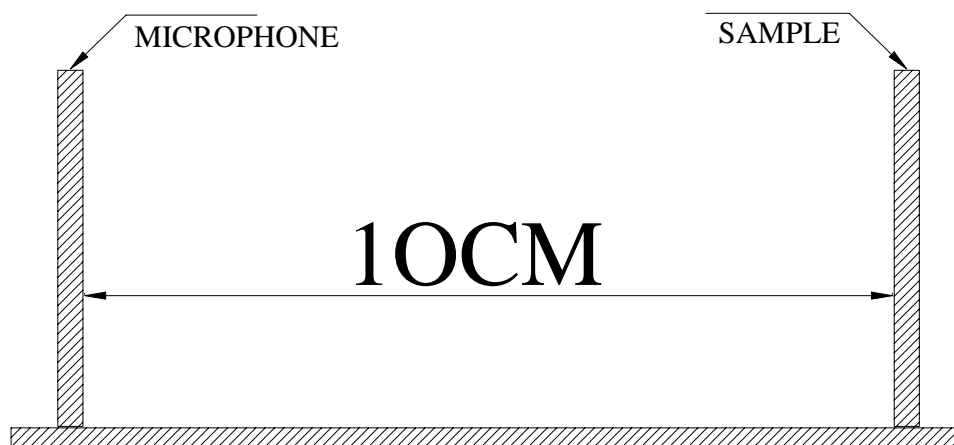

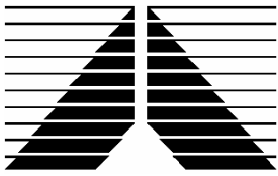

HITPOINT

TEL:8862-26013311

FAX:8862-26013898

NO.4 Lane 505, Zhongzheng Rd., Linkou Shiang, Taipei, Taiwan 24445 . R.O.C

5. RELIABILITY

ITEMS	METHOD OF TEST AND MEASUREMENTS	PERFORMANCE
<i>Coldness withstanding</i>	<i>After 98 hours of being exposed to -30°C environment, should be returned to normal environment for 2 hours, then re-proceed to test.</i>	<i>No abnormality shall exist</i>
<i>Hotness withstanding</i>	<i>After 98 hours of being exposed to +80°C environment, should be returned to normal environment for 2 hours, then re-proceed to test.</i>	<i>No abnormality shall exist</i>
<i>Humidity withstanding</i>	<i>After 98 hours of being exposed to 40°C 95%RH environment in actual operation, should be returned to normal environment for 2 hours, then re-proceed to test.</i>	<i>No abnormality shall exist</i>
<i>Durability</i>	<i>Testing after 1,000 hours actual continuous operation. (at standard measurement conditions)</i>	<i>No abnormality shall exist</i>
<i>Drop withstanding</i>	<i>A natural drop from 75cm high down to the ground.</i>	<i>No abnormality shall exist</i>
<i>Vibration withstanding</i>	<i>Vibration of 2,000 cycles per minute, 2mm amplitude, applied in X, Y and Z directions for 30 minutes each.</i>	<i>No abnormality shall exist</i>

6. PACKAGE METHOD

<1> 400pcs per box , Total 10 boxes per carton , total 4000pcs carton;

Volume: L*W*H=510*330*300mm

<2> RoHS Mark

